

Cold start injector

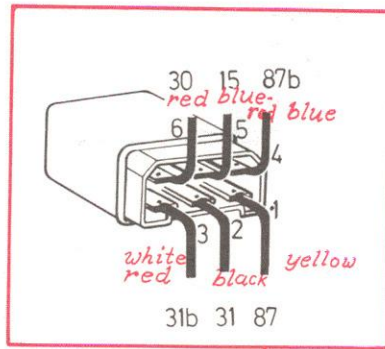

Electronic relay

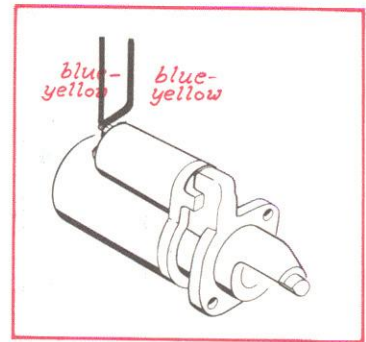

Starter motor

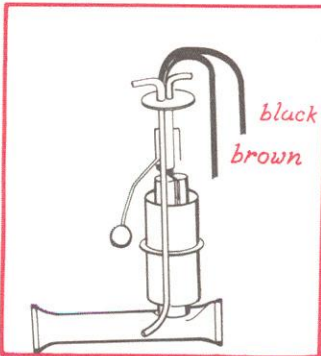

Fuel feed pump

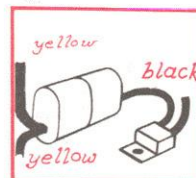
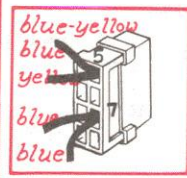

Fuse

Suppressor

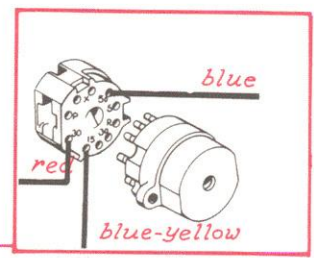

Ignition lock

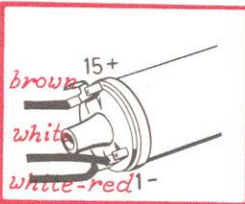

Ignition coil

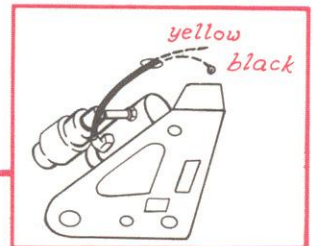
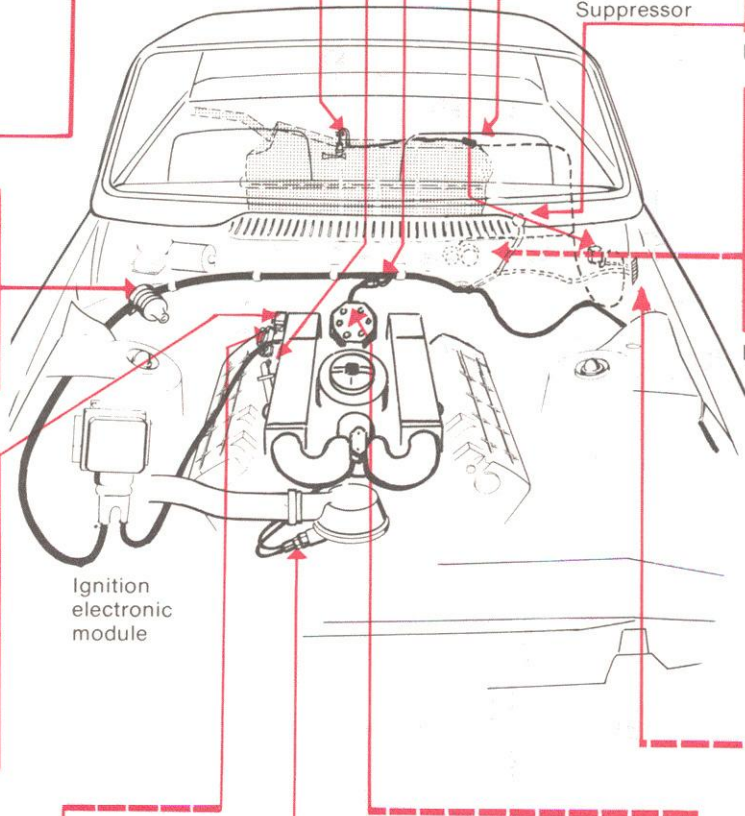

Fuel pump

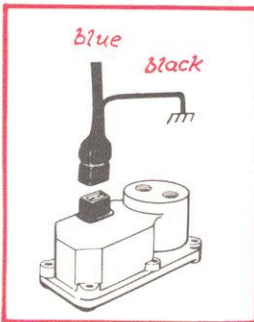

Control pressure regulator

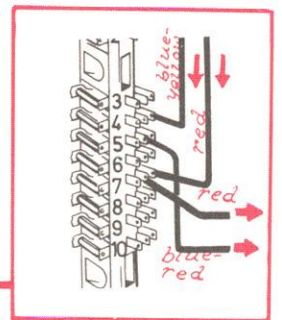

Fuse box

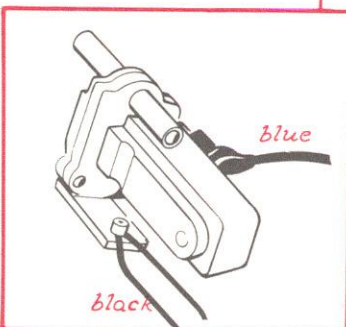

Auxiliary air valve

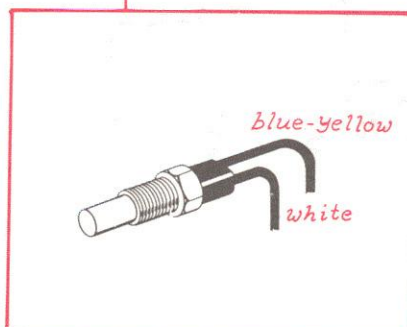

Thermal time switch

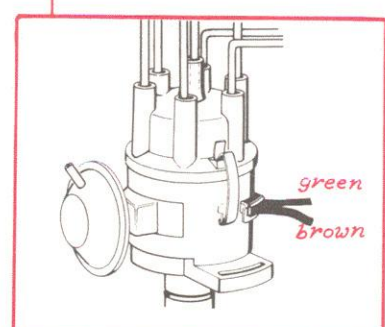

Distributor